

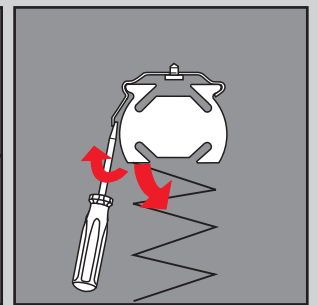

**Wichtig! Bitte mit der Pflegeanleitung aufbewahren!**  
**Important! Please keep together with care instructions!**  
**Let op! Bewaren samen met de hoodsinstructies!**  
**Important! Conserver ensemble avec les conseils d'entretien!**  
**Importante! Conservare con le istruzioni per la manutenzione!**  
**Важное указание! Просьба хранить вместе с руководством по уходу!**

# Cosiflor PL40 Slope

Montage · Fitting · Montage ·  
 Montaggio · Монтаж

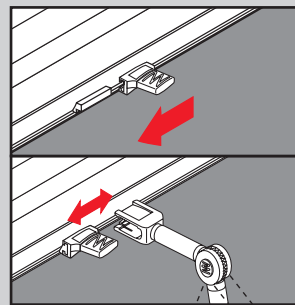
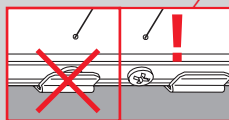
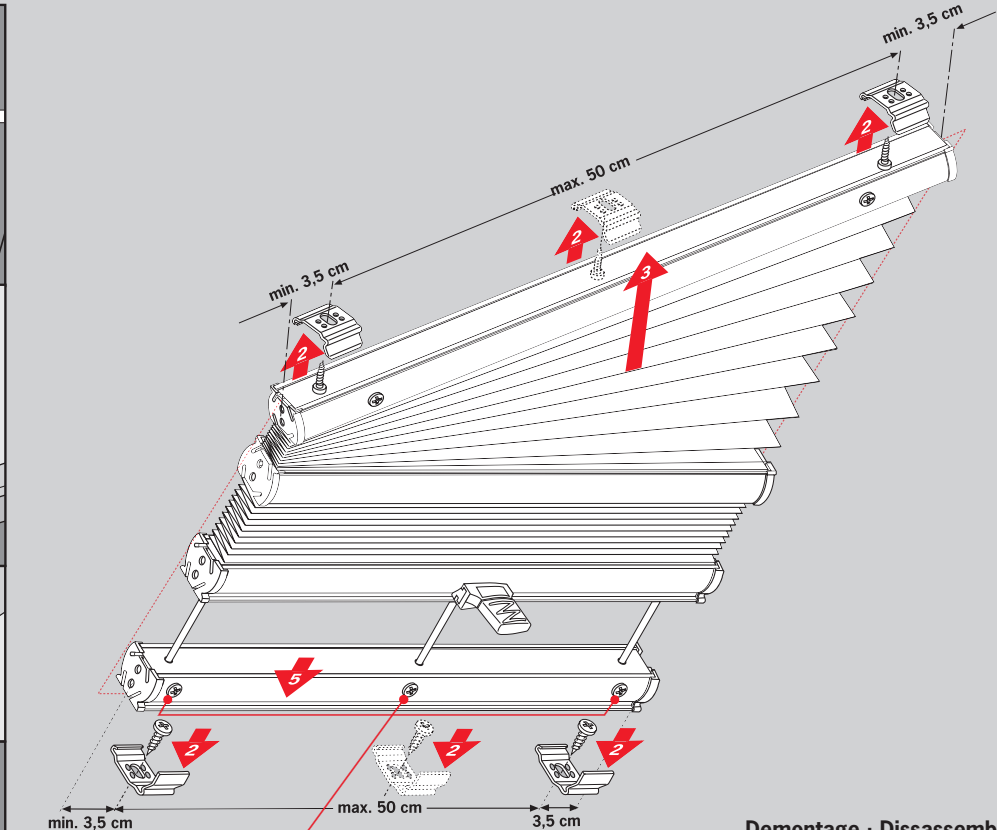
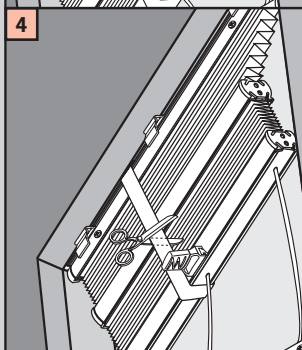
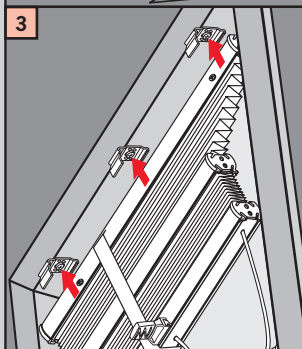
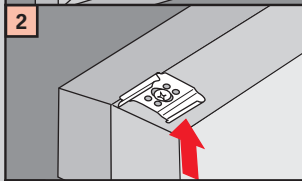
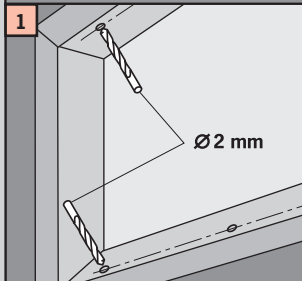
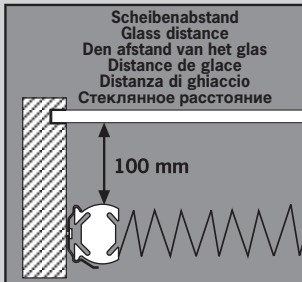

Demontage · Dissassembly  
 · Demontage · Démontage  
 · Smontaggio · Демонтаж

Drähte spannen · tension the wires · draden spannen  
 · tendre les fils · tirare il filu metallico · натягивать проволоку

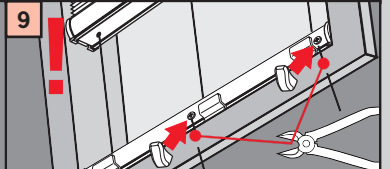
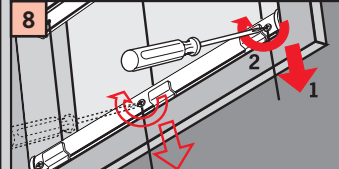
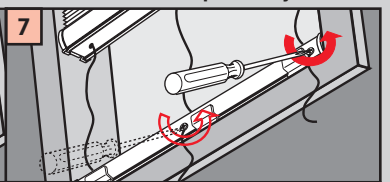
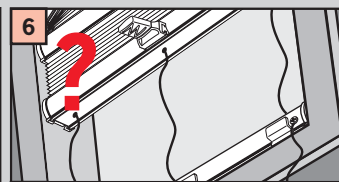



**Wichtig! Bitte mit der Pflegeanleitung aufbewahren!**  
**Important! Please keep together with care instructions!**  
**Let op! Bewaren samen met de houdsinstructies!**  
**Important! Conserver ensemble avec les conseils d'entretien!**  
**Importante! Conservare con le istruzioni per la manutenzione!**  
**Важное указание! ПроСьба хранить вместе с руководством по уходу!**

# Cosiflor PL40 Slope

Montage · Fitting · Montage ·  
 Montaggio · Монтаж

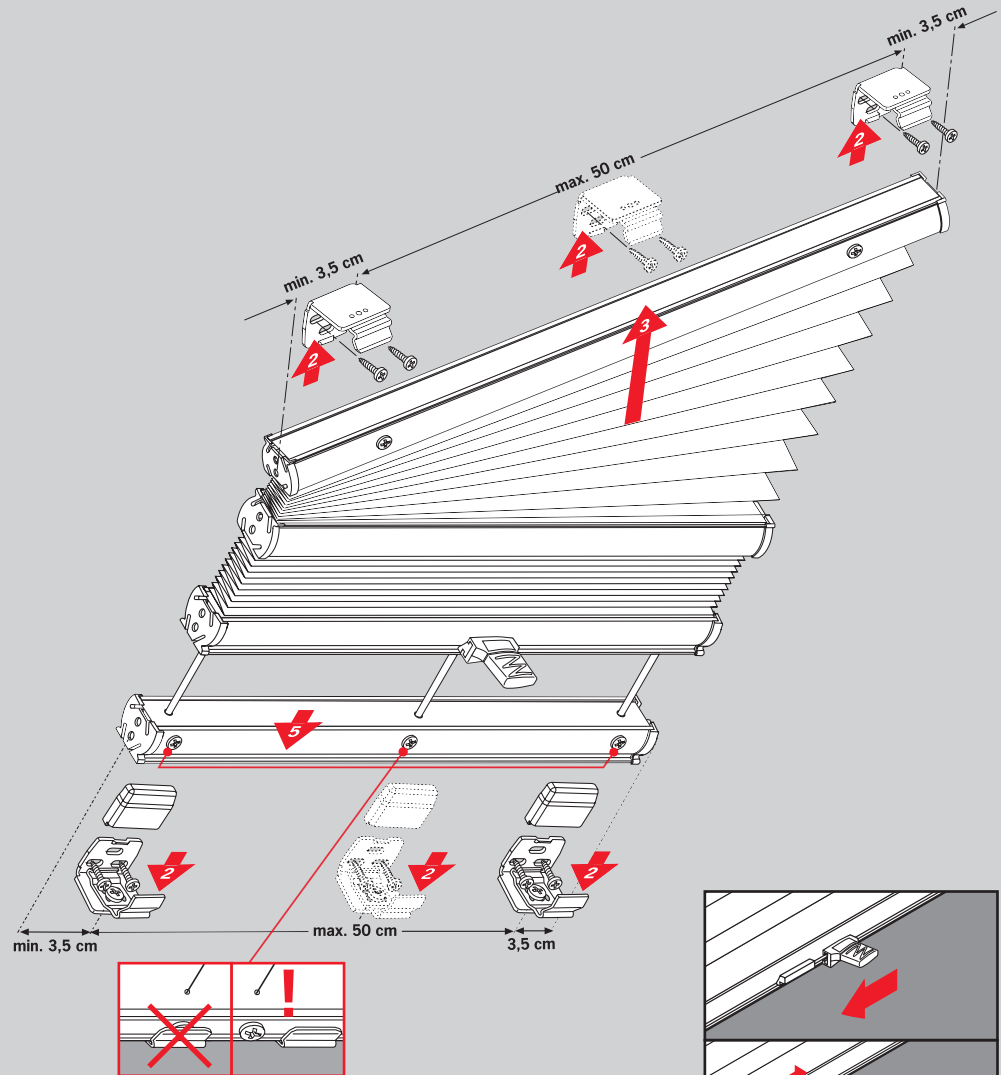
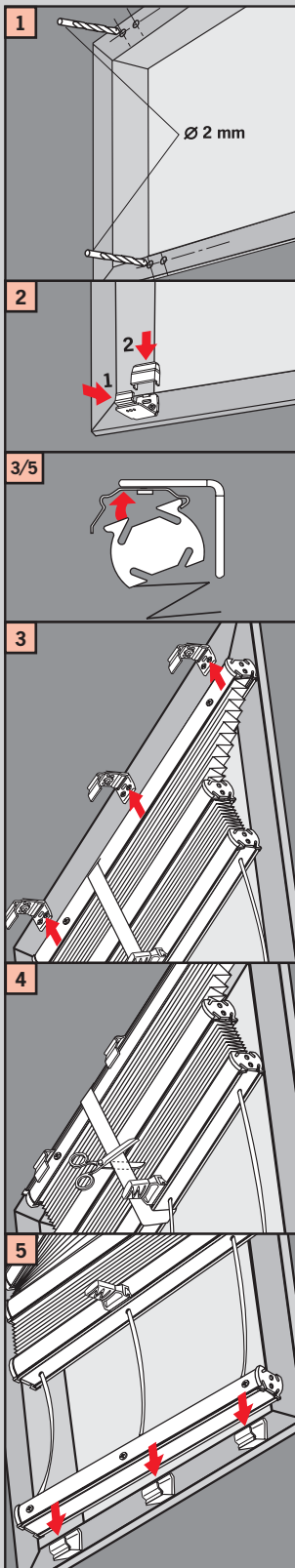

**Drähte spannen · tension the wires · draden spannen**  
**· tendre les fils · tirare il filo metallico · натягивать проволоку**

**Demontage · Dissassembly**  
**· Demontage · Démontage**  
**· Smontaggio · Демонтаж**