

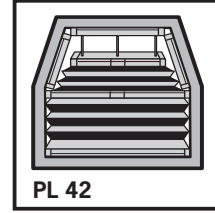

Wichtig! Bitte mit der Pflegeanleitung aufbewahren!
Important! Please keep together with care instructions!
Let op! Bewaren samen met de houدينstructies!
Important! Conserver ensemble avec les conseils d'entretien!
Importante! Conservare con le istruzioni per la manutenzione!
Важное указание! ПроСьба хранить вместе с руководством по уходу!

Cosiflor PL41, PL42

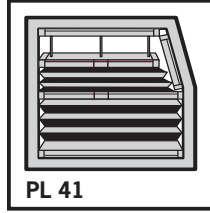

Montage · Fitting · Montage · Montaggio · Монтаж

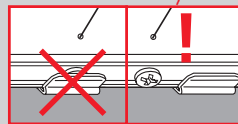
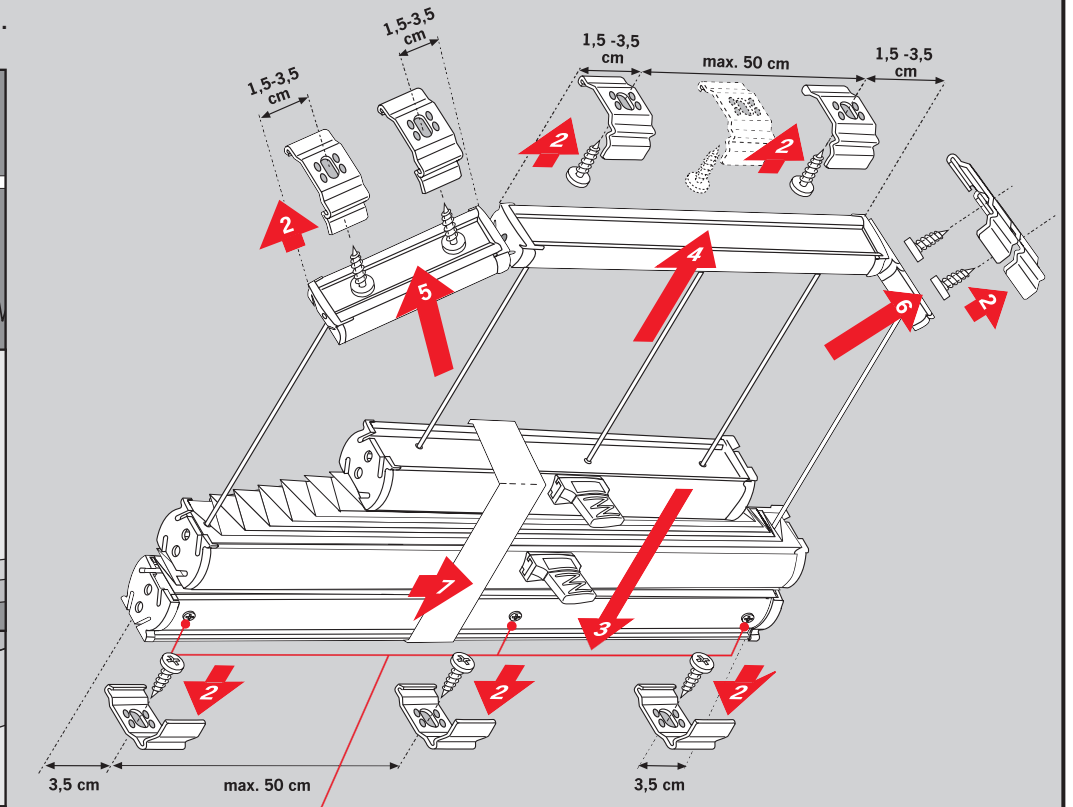
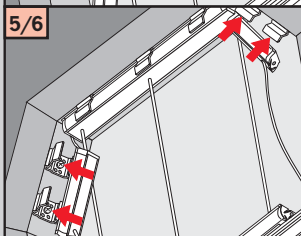
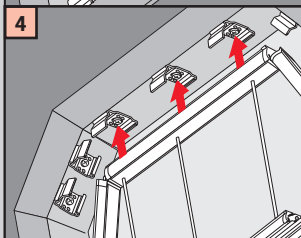
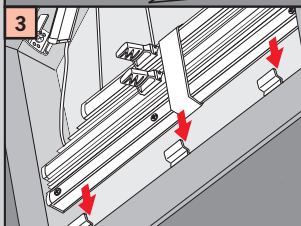
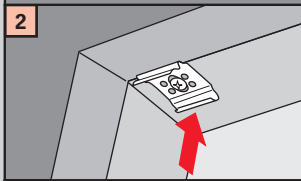
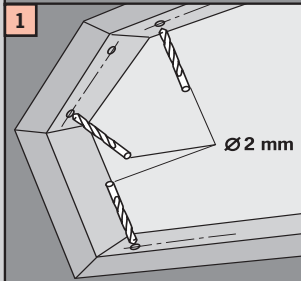
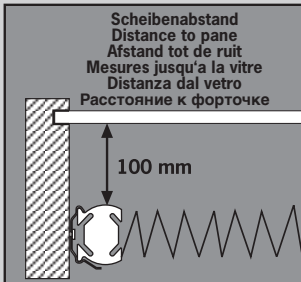

Bedienung · Operation
 · Bedienung · Manœuvre
 · Comando · Обслуживание

Demontage · Dissassembly
 · Demontage · Démontage
 · Smontaggio · Демонтаж

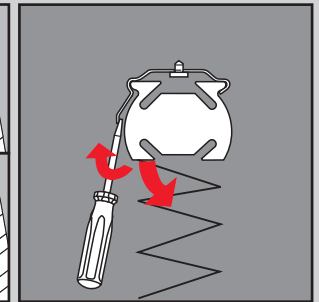
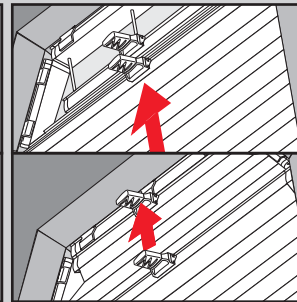
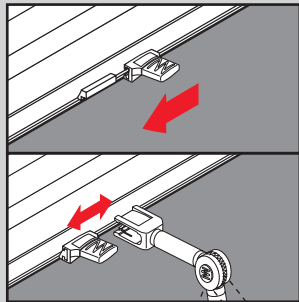

Drähte spannen · tension the wires · draden spannen
 · tendre les fils · tirare il filo metallico · натягивать проволоку

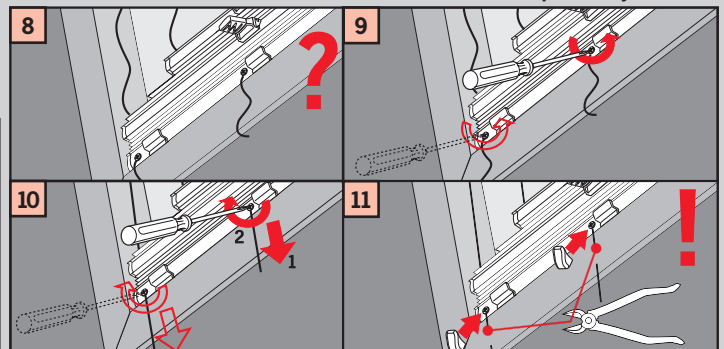



Wichtig! Bitte mit der Pflegeanleitung aufbewahren!
Important! Please keep together with care instructions!
Let op! Bewaren samen met de houidinstructies!
Important! Conserver ensemble avec les conseils d'entretien!
Importante! Conservare con le istruzioni per la manutenzione!
Важное указание! ПроСьба хранить вместе с руководством по уходу!

Cosiflor PL41, PL42

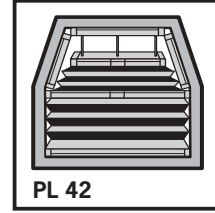
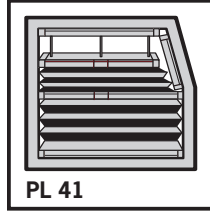

Montage · Fitting · Montage · Montaggio · Монтаж

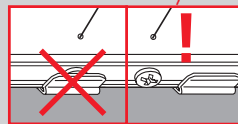
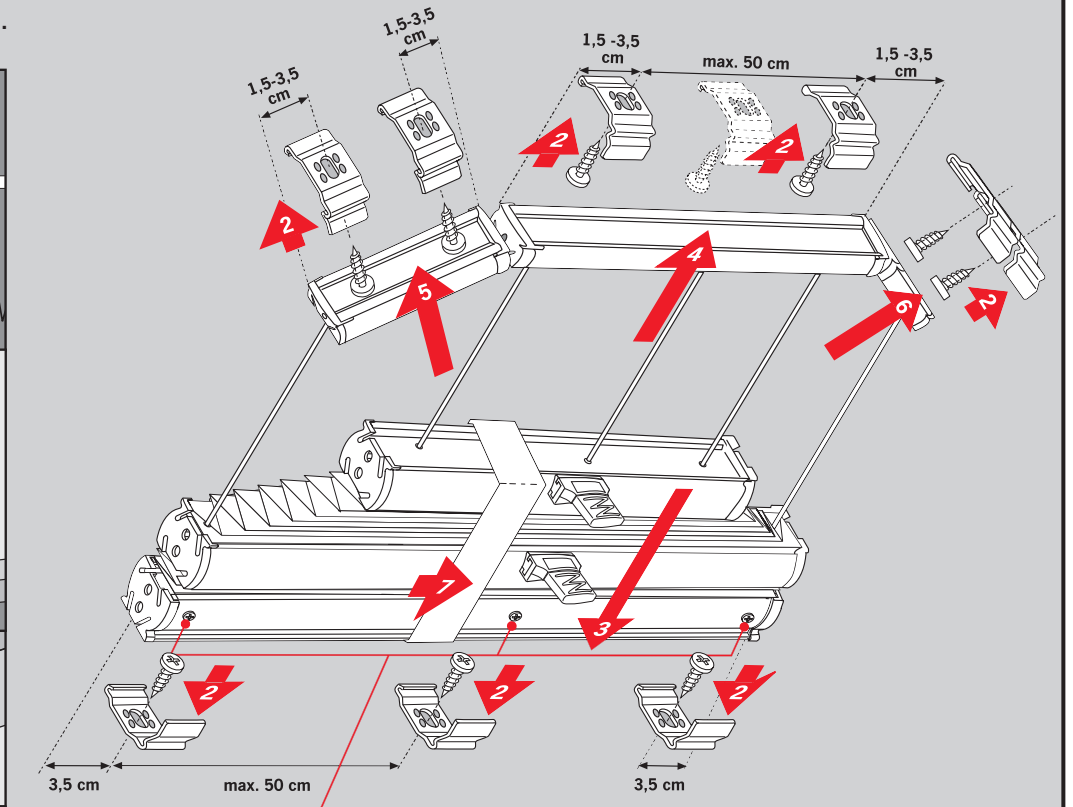
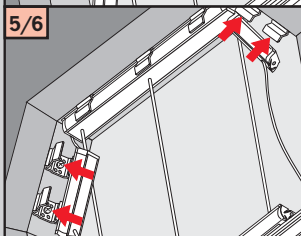
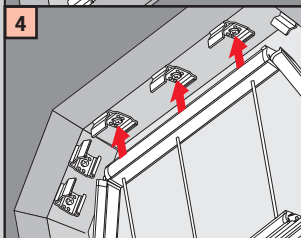
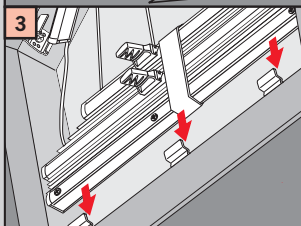
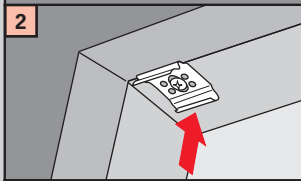
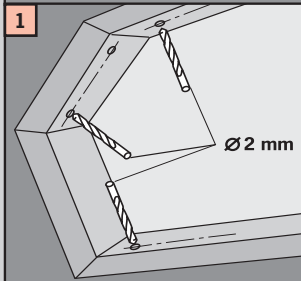
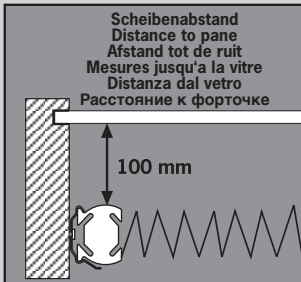

Bedienung · Operation
 · Bedienung · Manœuvre
 · Comando · Обслуживание

Demontage · Dissassembly
 · Demontage · Démontage
 · Smontaggio · Демонтаж

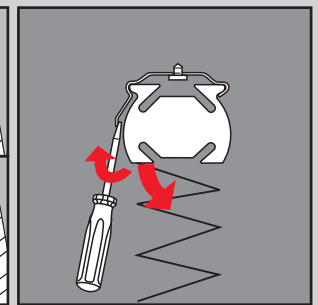
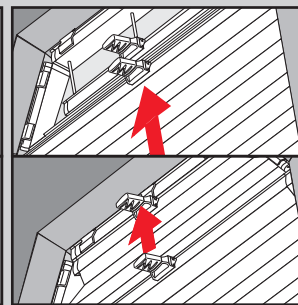
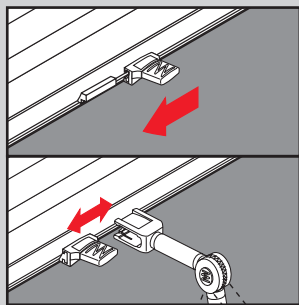

Drähte spannen · tension the wires · draden spannen
 · tendre les fils · tirare il filo metallico · натягивать проволоку

