



Wichtig! Bitte mit der Pflegeanleitung aufbewahren!
Important! Please keep together with care instructions!
Let op! Bewaren samen met de onderhoudsinstructies!
Important! Conserver ensemble avec les conseils d'entretien!
Importante! Conservare con le istruzioni per la manutenzione!
Важное указание! Просьба хранить вместе с руководством по уходу!

Cosiflor DF 10/30

Falzmontage, Top fixing, Bevestiging in de sponning,
 Dans la feuillure, Образование складок

Bitte nur beiliegende Schrauben verwenden.
 Please use enclosed screws only.
 Gelieve enkel bijgevoegde schroeven te gebruiken.
 Se servir exclusivement des vis jointes.
 Si prega di utilizzare solo le viti allegate.
 Просьба использовать только приложенные винты.

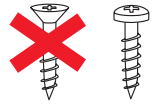

Wichtig! • Important! • Let op! • Important!
Importante! • Важно!

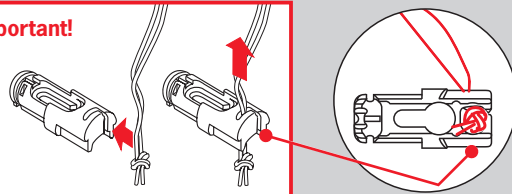
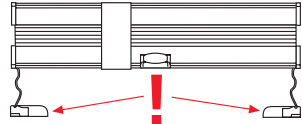

VELUX
 Vorbereitung • Preparation
 Voorbereiding • Préparation
 Preparazione • Подготовка

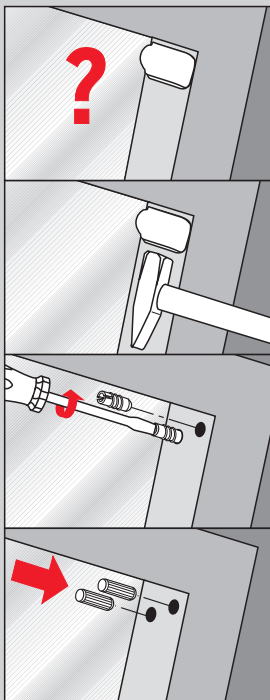

VELUX
 Vorbereitung • Preparation
 Voorbereiding • Préparation
 Preparazione • Подготовка

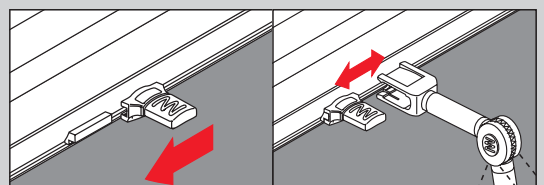
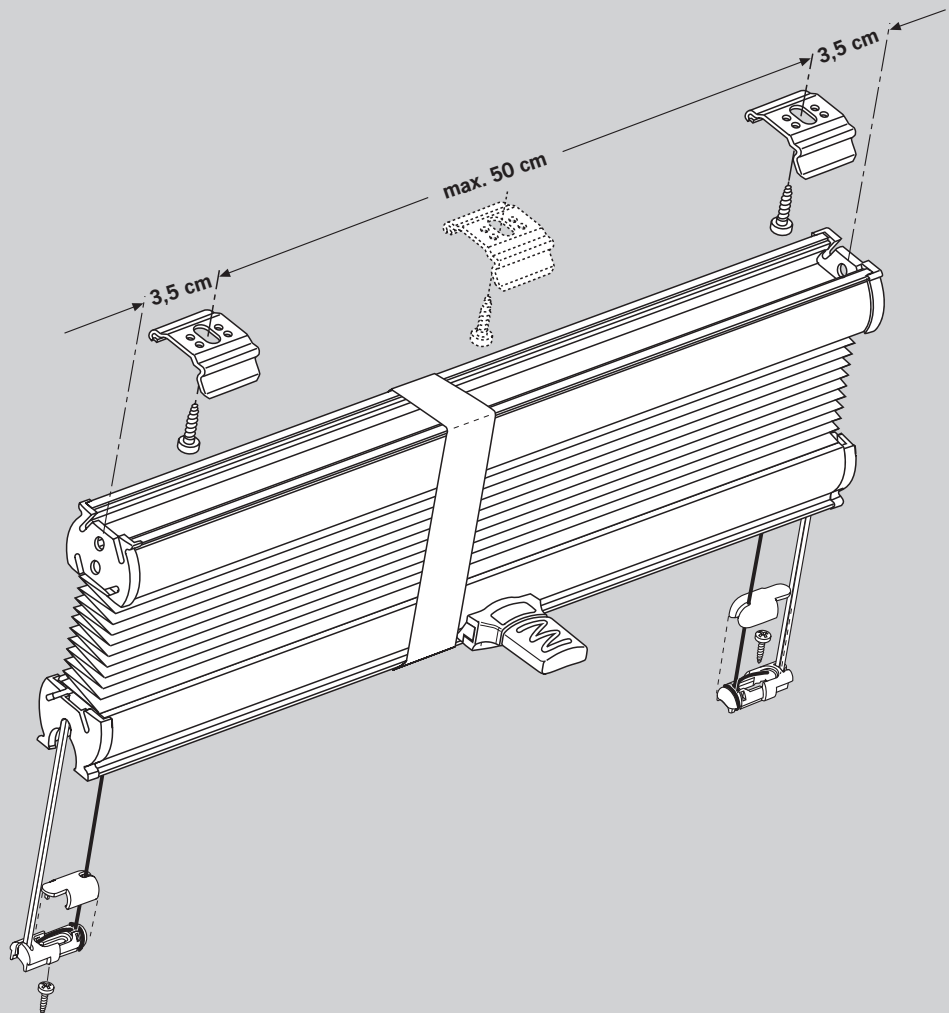
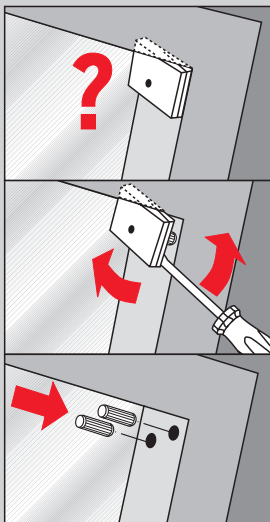

Montage der Anlage bündig mit der Fenstervorderkante.

The system must be installed flush with the front edge of the window.

Montage van de plissé precies aan de voorkant van de glaslijst.

Montage de l'installation à fleur avec l'arête avant de la fenêtre.

Montaggio dell'impianto a paro con il bordo anteriore della finestra.

штора монтируется в проём окна, причём низ шторы опускается до рамы.

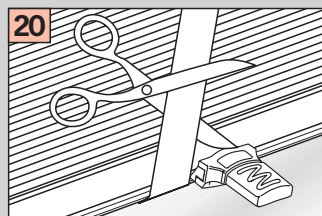
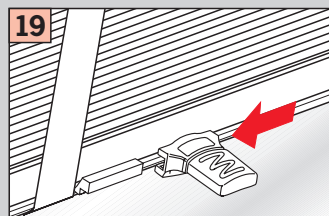
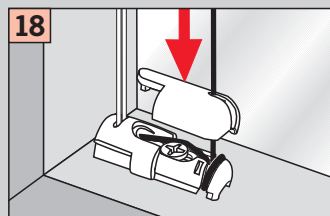
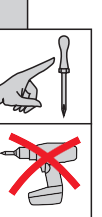
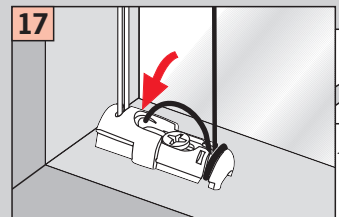
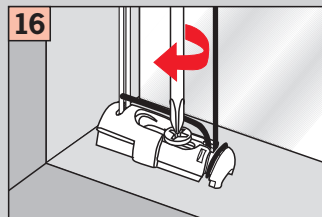
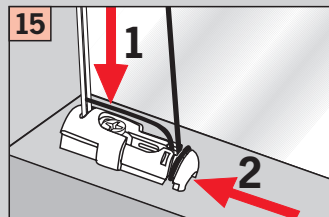
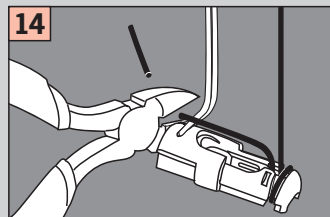
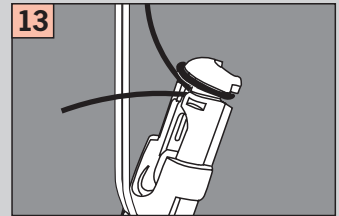
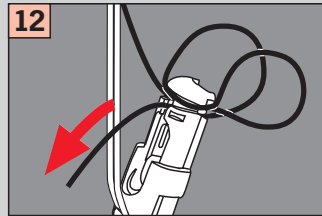
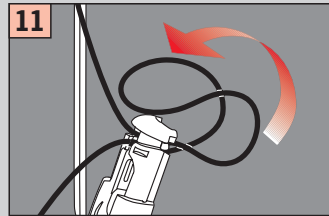
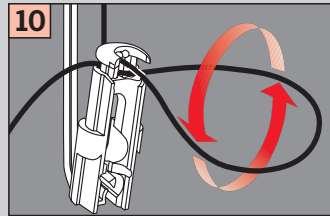
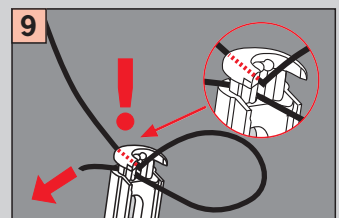
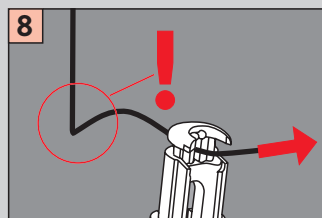
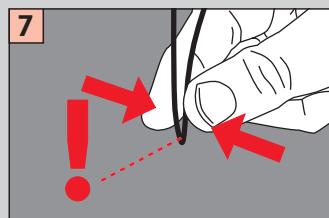
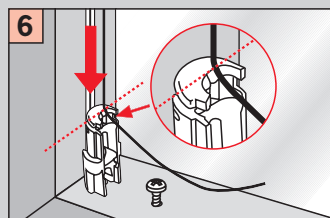
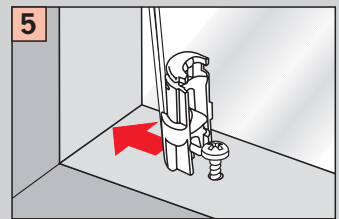
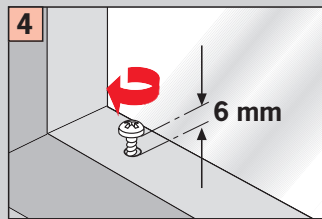
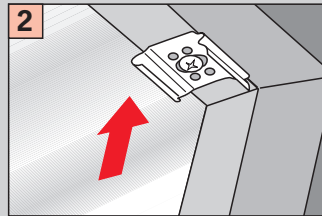
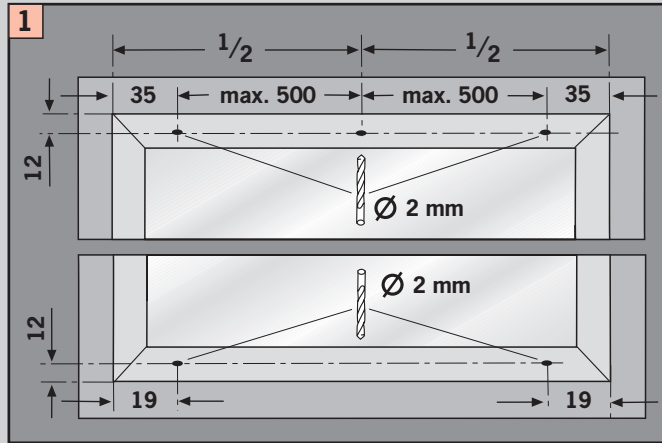
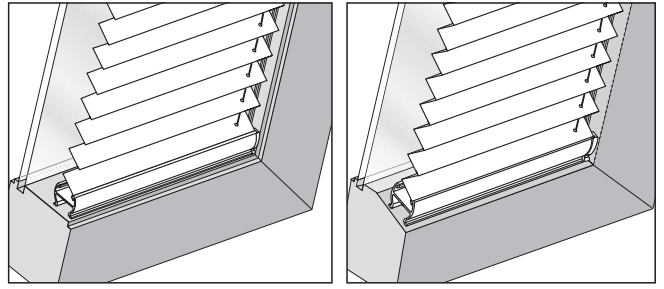

Demontage • Disassembly • Demontage • Démontage • Smontaggio • Демонтаж

